

Micron

INSTALLATION TECHNICAL FEATURES CONFIGURATION SOFTWARE



Copy of the original Instructions

ENGLISH



Contents

INTRODUCTION	3
Beam positioning	3
Working range	4
ELECTRICAL CONNECTIONS.....	5
Emitter connections (AV/AC/B models).....	5
Emitter connections (C models)	5
Receiver connections (AV/AC models)	6
Receiver connections (B models).....	6
Receiver connections (C models)	7
Micron-PC connection via USB cable (<i>Reer CSU M5 - 1250900</i>).....	7
Push-Pull Outputs (models with step 10mm, 20mm, 30mm STANDARD MODELS).....	8
Warnings about connection cables	8
INDICATOR LAMPS.....	9
TECHNICAL FEATURES	10
Mechanical dimensions (<i>all measurements are in mm</i>)	15
CONFIGURATION SOFTWARE.....	16
Using the <i>Reer MICRONCONFIGURATOR</i> program	16
Preliminary Operations.....	16
Connecting/disconnecting the light curtain	17
Initial configuration (1).....	17
Sync configuration:	17
Receiver sensitivity configuration (only models 25mm, 50mm, 75mm, 10mm H, 30mm H):	17
Orientation configuration:	17
Scan cycle configuration:	17
Input pin configuration (2)	18
TEACH IN mode (3)	19
Analog output configuration (AC/AV models) (4)	20
Digital output configuration (5)	21
The CONDITION box	22
RS485 output configuration (B models) (6)	23
Micron on Network	24
Data transmission parameters.....	25
Data to be sent	25
Data transmission mode	25
Comparator mode.....	26
Protocol mode	27
Example of data packet in comparator mode	28
Example of data packet in protocol mode.....	29
Monitoring light curtain status	30
AV/AC models	30
B models	31

 Micron light curtains **MUST NOT** be used as safety devices for protection of operators in hazardous areas.

INTRODUCTION

The Micron photoelectric light curtain is a multi-beam optoelectronic system consisting of an emitter and a receiver, used to detect or measure objects.

The two units can be synchronised via optical link or cable.

The status of the light curtain outputs (which reside in the receiver) changes as soon as a measurement is performed (or an object is detected).

Beam positioning

The following figure shows the arrangement of the beams and their numbering:

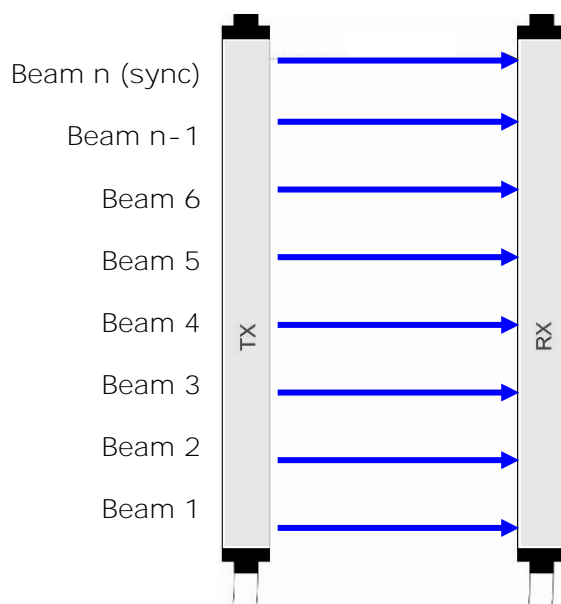

Figure 1

- ➔ Note that beams must always be numbered starting from the bottom, as shown in figure 1. If synchronised via cable, the last beam can also be used for measurements.
- ➔ With optical synchronisation, the uppermost beam must never be obstructed as this would interrupt the measurement function.

Working range

➔ Particular operating conditions may affect the sensing level of photo-electric devices. In environments characterised by fog, rain, fumes or dust, to always guarantee correct operation of the appliance, it is advisable to apply suitable correction factors Cf so as to maximum working range values. In these cases:

$$Pu = Pm \times Fc$$

where Pu and Pm are, respectively, the working and maximum range expressed in metres.

The recommended correction factors CF are indicated in the table below.

OPERATING CONDITIONS	CORRECTION FACTOR Cf
Fog	0.25
Vapours	0.50
Dust	0.50
Dense fumes	0.25

➔ If the device is installed in environments characterised by sudden changes in temperature, suitable precautions must be taken to prevent the formation of condensation on the mirrors, which could impair detection capability.

ELECTRICAL CONNECTIONS

- ➔ Perform the connections as shown in below tables, in order to ensure the correct functioning of the barrier.
- ➔ We recommend the use of separate power supplies for the barrier and for other electrical power equipment (electric motors, inverters, frequency converters) or other sources of disturbance.
- ➔ We recommend the use of a shielded cable for the connection of serial RS-485 (Micron B).

Emitter connections (AV/AC/B models)

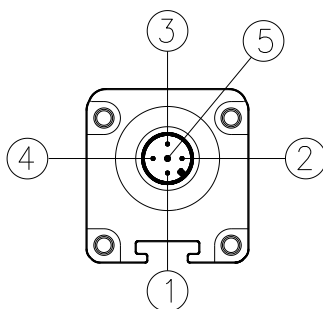

Figure 2

PIN	COLOUR	NAME	TYPE	DESCRIPTION
1	Brown	24VDC	-	24 VDC power supply
2	White	RANGE	INPUT	24 VDC input → HIGH range 0 DC input → LOW range
3	Blue	0VDC	-	0 VDC power supply
4	Black	SYNC	INPUT	RX-TX SYNC INPUT (OPTIONAL)
5	Grey	PE	-	Ground connection

Table 1 - M12, 5-pole

Emitter connections (C models)

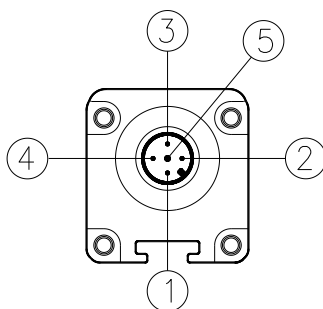

Figure 3

PIN	COLOUR	NAME	TYPE	DESCRIPTION
1	Brown	24VDC	-	24 VDC power supply
2	White	RANGE	INPUT	24 VDC input → HIGH range 0 DC input → LOW range
3	Blue	0VDC	-	0 VDC power supply
4	Black	-	-	Not used
5	Grey	PE	-	Ground connection

Table 2 - M12, 5-pole

Receiver connections (AV/AC models)

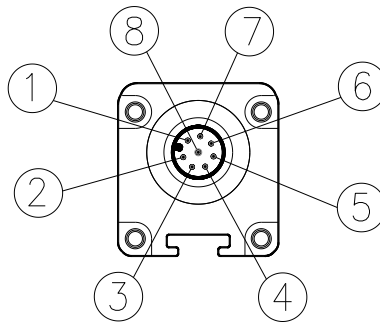

Figure 4

PIN	COLOUR	NAME	TYPE	DESCRIPTION	OPERATION
1	White	OUT2/SYNC	OUTPUT	Static output 2 / RX-TX sync	24 VDC, 100 mA
2	Brown	24VDC	-	24 VDC power supply	-
3	Green	OUT1	OUTPUT	Static output 1	24 VDC, 100 mA
4	Yellow	INPUT	INPUT	Input with programmable functions	Compliant with EN 61131-2
5	Grey	ANALOG_OUT2	OUT	Analog output 2 (AC)	4÷20 mA current output *
				Analog output 2 (AV)	0÷10 VDC voltage output *
6	Pink	ANALOG_OUT1	OUT	Analog output 1 (AC)	4÷20 mA current output *
				Analog output 1 (AV)	0÷10 VDC voltage output *
7	Blue	0VDC	-	0 VDC power supply	-
8	Red	PE	-	Ground connection	-

Table 3 - M12, 8-pole RX

* (Refers to 0 VDC, pin 7)

Receiver connections (B models)

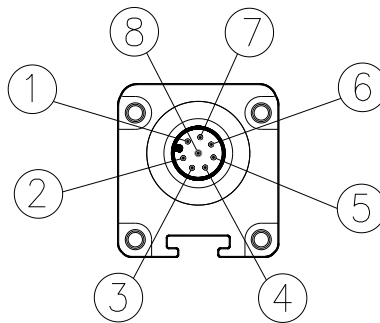
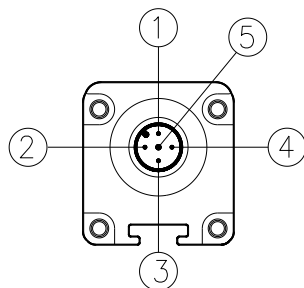

Figure 5

PIN	COLOUR	NAME	TYPE	DESCRIPTION	OPERATION
1	White	OUT2/SYNC	OUTPUT	Static output 2 / RX-TX sync	24 VDC, 100 mA
2	Brown	24VDC	-	24 VDC power supply	-
3	Green	OUT1	OUTPUT	Static output 1	24 VDC, 100 mA
4	Yellow	INPUT	INPUT	Input with programmable functions	Compliant with EN 61131-2
5	Grey	LINE - (A)	IN/OUT	RS485 -(A) serial line	RS-485
6	Pink	LINE + (B)	IN/OUT	RS485 +(B) serial line	RS-485
7	Blue	0VDC	-	0 VDC power supply	-
8	Red	PE	-	Ground connection	-

Table 4 - M12, 8-pole RX

Receiver connections (C models)



PIN	COLOUR	NAME	TYPE	DESCRIPTION	OPERATION
1	Brown	24 VDC	-	24 VDC power supply	-
2	White	OUT2	OUTPUT	Static output 2	DARK-ON 24 VDC, 100 mA
3	Blue	0 VDC	-	0 VDC power supply	-
4	Black	OUT1	OUTPUT	Static output 1	LIGHT-ON 24 VDC, 100 mA
5	Grey	PE	-	Ground connection	-

Table 5 - M12, 5-pole RX (C models)

Micron-PC connection via USB cable (ReeR CSU M5 - 1250900)

AC/AV/B models are fitted with an M5 connector (leading from the receiver) for connecting the light curtain to a PC on which the Micron configuration SW is installed.



Figure 6

➔ First, connect the M5 connector to the light curtain, then insert the USB connector into the PC.

Push-Pull Outputs (models with step 10mm, 20mm, 30mm STANDARD MODELS)

The models with step 10mm, 20mm, 30mm STANDARD (not H models) are provided with digital outputs 0-24VDC *Push-Pull type*.

These outputs can operate both in PNP and NPN mode. At the power-on the barrier recognizes the type of connection of the load and operates accordingly.

The two outputs are independent and can be connected to a load such as a PNP and the other to a load NPN. The figure below shows all the possible connections.

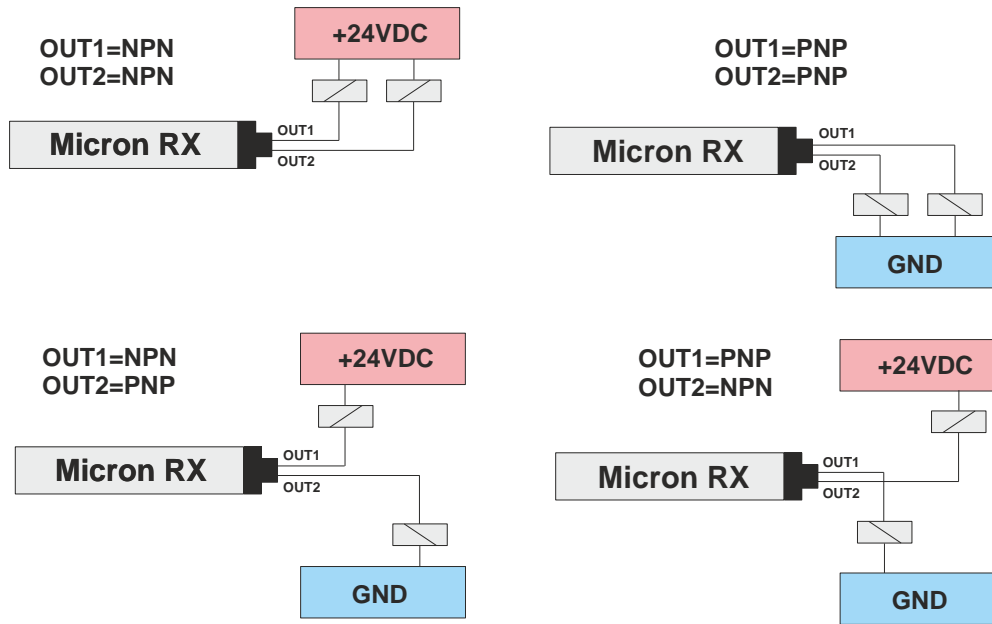

➔ Warning: it is essential to turn off and on the barrier Micron after changing the output connections.

Warnings about connection cables

- Cables must not be more than 50m long.
- Keep the power supply to the light curtain separate from that to other electric power equipment (electric motors, inverters, frequency converters) or other sources of disturbance.
- Connect the emitter and the receiver to the ground socket.
- Connection cables must follow different paths from other power cables.

➔ The emitter, the receiver and the device connected to the outputs must have the ground (0 VDC) connection in common.

INDICATOR LAMPS

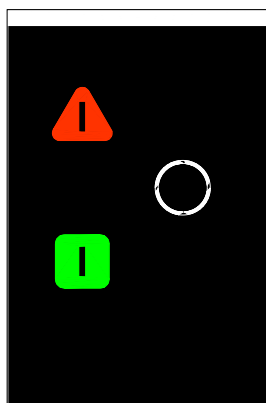

Figure 7

EMITTER (AC/AC/B/C)	
TRI-COLOUR LEDS (Red/Green/Orange)	MEANING
RED	System start.
RED BLINKING	FAIL condition
GREEN	Normal operation. At power on: <ul style="list-style-type: none"> • 2 slow blinks -> Low range • 2 fast blinks -> High range
ORANGE BLINKING	No synchronisation via cable

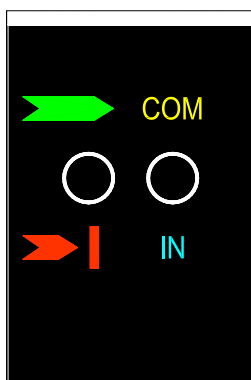

Figure 8

RECEIVER (AC/AV/B)		
BI-COLOUR (Red/Green)	BI-COLOUR (Orange/Blue)	MEANING
RED	-	Light curtain obstructed
GREEN	-	Light curtain clear
-	ORANGE	Connected to PC via USB
-	BLUE	Input active/recognition activated
-	BLUE BLINKING	Pattern recognition
-	BLUE 3 BLINKS	No pattern
RED BLINKING	-	FAIL condition
RED CONSTANT WITH 1 BREAK	-	No sync
RED/GREEN WITH 3 BREAKS	-	Analog Output Overload (AV models)
		Analog Outputs not connected (AC models)
RED/GREEN WITH 4 BREAKS	-	Digital Outputs overload or failure (models 10mm, 20mm, 30mm)

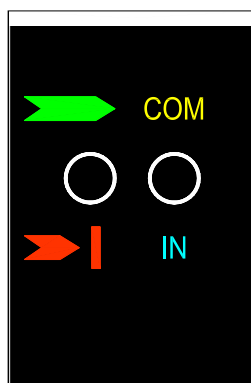

Figure 9

RECEIVER (C)		
BI-COLOUR (Red/Green)	BI-COLOUR (Orange/Blue)	MEANING
RED	-	Light curtain obstructed
GREEN	-	Light curtain clear
RED BLINKING	-	FAIL condition
RED CONSTANT WITH 1 BREAK	-	No sync

TECHNICAL FEATURES

Micron 5mm SAFETY CURTAIN TECHNICAL FEATURES				
Model		AV/AC	B	C
Operating range (REDUCED) (selectable from software)	m	0÷0,6 / 0,6÷1,5	0÷0,6 / 0,6÷1,5	0÷1 / 0,6÷2,5
Operating range (NORMAL) (selectable from software)	m	0÷1 / 0,6÷2,5	0÷1 / 0,6÷2,5	
Power supply	VDC	24 ± 20%	24 ± 20%	24 ± 20%
Connections		M12 - 5-pole emitter / M12 - 8-pole receiver M5 - 4-pole connector (USB) for software configuration	M12 - 5-pole emitter / M12 - 8-pole receiver M5 - 4-pole connector (USB) for software configuration	M12 - 5-pole emitter / M12 - 5-pole receiver
Measurement time		(70 us * number of beams + 500 us)*n (n = 1÷3 based on the scan cycles configured)		(70 us * number of beams + 500 us)*2
Synchronisation		Optical or via cable, selectable		Optical
Max power	W	1 (Emitter)/ 2 (Receiver)	1 (Emitter)/ 2 (Receiver)	1 (Emitter)/ 2 (Receiver)
Digital outputs		2 static outputs: 100 mA @ 24 VDC PNP (configurable functions)	2 static outputs: 100 mA @ 24 VDC PNP (configurable functions)	2 static outputs: 100 mA @ 24 VDC PNP (antivalent logic)
Analog outputs (AC MODELS)		2 current outputs 4÷20 mA ± 2% (refers to 0 VDC) (configurable functions) <i>OPERATING WITH 10 ÷ 470 Ohm LOAD RESISTOR</i>	-	-
Analog outputs (AV MODELS)		2 voltage outputs 0÷10 VDC ± 2% (Refers to 0 VDC) / 10 mA max (configurable functions)	-	-
RS-485 output (B MODELS)		-	Compliant with the RS-485 standard min Baud Rate = 2400 / max Baud Rate =115200 (configurable function)	-
Inputs		Input with configurable functions (0/24 VDC)	Input with configurable functions (0/24 VDC)	-
Minimum duration of Input signal (ms)		5	5	-
Max. connect. length	m	50	50	100
Operating temp.	°C	-10 ÷ 55°C	-10 ÷ 55°C	-10 ÷ 55°C
Protection class		IP 65 - IP 67	IP 65 - IP 67	IP 65 - IP 67

Micron 10mm, 20mm, 30mm MEASURE CURTAIN TECHNICAL FEATURES			
Model	AV/AC	B	C
Operating range	m	0÷2 / 1÷10	0÷2 / 1÷10
Power supply	VDC	24 ± 20%	24 ± 20%
Connections	M12 - 5-pole emitter / M12 - 8-pole receiver M5 - 4-pole connector (USB) for software configuration	M12 - 5-pole emitter / M12 - 8-pole receiver M5 - 4-pole connector (USB) for software configuration	M12 - 5-pole emitter / M12 - 5-pole receiver
Measurement time	(70 us * number of beams + 500 us)*n (n = 1÷3 based on the scan cycles configured)		(70 us * number of beams + 500 us)*2
Synchronisation	Optical or via cable, selectable		Optical
Max power	W	1 (Emitter)/ 2 (Receiver)	1 (Emitter)/ 2 (Receiver)
Digital outputs	2 static outputs: 100 mA @ 24VDC Push-Pull (configurable functions)	2 static outputs: 100 mA @ 24VDC Push-Pull (configurable functions)	2 static outputs: 100 mA @ 24VDC Push-Pull (antivalent logic)
Analog outputs (AC MODELS)	2 current outputs 4÷20 mA ± 2% (refers to 0 VDC) (configurable functions) <i>OPERATING WITH 10 ÷ 470 Ohm LOAD RESISTOR</i>	-	-
Analog outputs (AV MODELS)	2 voltage outputs 0÷10 VDC ± 2% (Refers to 0 VDC) / 10 mA max (configurable functions)	-	-
RS-485 output (B MODELS)	-	Compliant with the RS-485 standard min Baud Rate = 2400 / max Baud Rate =115200 (configurable function)	-
Inputs	Input with configurable functions (0/24 VDC)	Input with configurable functions (0/24 VDC)	-
Minimum duration of Input signal (ms)	5	5	-
Max. connect. length	m	50	100
Operating temp.	°C	-10 ÷ 55°C	-10 ÷ 55°C
Protection class	IP 65 - IP 67	IP 65 - IP 67	IP 65 - IP 67

Micron 10mm, 30mm (H) MEASURE CURTAIN TECHNICAL FEATURES			
Model	AVH / ACH	BH	CH
Operating range (REDUCED) (selectable from software)	m 0÷3 / 0÷8	0÷3 / 0÷8	0÷8 / 1÷18
Operating range (NORMAL) (selectable from software)	m 0÷8 / 1÷18	0÷8 / 1÷18	
Power supply	VDC 24 ± 20%	24 ± 20%	24 ± 20%
Connections	M12 - 5-pole emitter / M12 - 8-pole receiver M5 - 4-pole connector (USB) for software configuration	M12 - 5-pole emitter / M12 - 8-pole receiver M5 - 4-pole connector (USB) for software configuration	M12 - 5-pole emitter / M12 - 5-pole receiver
Measurement time	(70 us * number of beams + 500 us)*n (n = 1÷3 based on the scan cycles configured)		(70 us * number of beams + 500 us)*2
Synchronisation	Optical or via cable, selectable		Optical
Max power	W 1 (Emitter)/ 2 (Receiver)	1 (Emitter)/ 2 (Receiver)	1 (Emitter)/ 2 (Receiver)
Digital outputs	2 static outputs: 100 mA @ 24 VDC PNP (configurable functions)	2 static outputs: 100 mA @ 24 VDC PNP (configurable functions)	2 static outputs: 100 mA @ 24 VDC PNP (antivalent logic)
Analog outputs (AC MODELS)	2 current outputs 4÷20 mA ± 2% (refers to 0 VDC) (configurable functions) <i>OPERATING WITH 10 ÷ 470 Ohm LOAD RESISTOR</i>	-	-
Analog outputs (AV MODELS)	2 voltage outputs 0÷10 VDC ± 2% (Refers to 0 VDC) / 10 mA max (configurable functions)	-	-
RS-485 output (B MODELS)	-	Compliant with the RS-485 standard min Baud Rate = 2400 / max Baud Rate =115200 (configurable function)	-
Inputs	Input with configurable functions (0/24 VDC)	Input with configurable functions (0/24 VDC)	-
Minimum duration of Input signal (ms)	5	5	-
Max. connect. length	m 50	50	100
Operating temp.	°C -10 ÷ 55°C	-10 ÷ 55°C	-10 ÷ 55°C
Protection class	IP 65 - IP 67	IP 65 - IP 67	IP 65 - IP 67

Micron 25mm, 50mm, 75mm SAFETY CURTAIN TECHNICAL FEATURES				
Model		AV/AC	B	C
Operating range (REDUCED) (selectable from software)	m	0÷3 / 0÷8	0÷3 / 0÷8	0÷8 / 1÷18
Operating range (NORMAL) (selectable from software)	m	0÷8 / 1÷18	0÷8 / 1÷18	
Power supply	VDC	24 ± 20%	24 ± 20%	24 ± 20%
Connections		M12 - 5-pole emitter / M12 - 8-pole receiver M5 - 4-pole connector (USB) for software configuration	M12 - 5-pole emitter / M12 - 8-pole receiver M5 - 4-pole connector (USB) for software configuration	M12 - 5-pole emitter / M12 - 5-pole receiver
Measurement time		(70 us * number of beams + 500 us)*n (n = 1÷3 based on the scan cycles configured)		(70 us * number of beams + 500 us)*2
Synchronisation		Optical or via cable, selectable		Optical
Max power	W	1 (Emitter)/ 2 (Receiver)	1 (Emitter)/ 2 (Receiver)	1 (Emitter)/ 2 (Receiver)
Digital outputs		2 static outputs: 100 mA @ 24 VDC PNP (configurable functions)	2 static outputs: 100 mA @ 24 VDC PNP (configurable functions)	2 static outputs: 100 mA @ 24 VDC PNP (antivalent logic)
Analog outputs (AC MODELS)		2 current outputs 4÷20 mA ± 2% (refers to 0 VDC) (configurable functions) <i>OPERATING WITH 10 ÷ 470 Ohm LOAD RESISTOR</i>	-	-
Analog outputs (AV MODELS)		2 voltage outputs 0÷10 VDC ± 2% (Refers to 0 VDC) / 10 mA max (configurable functions)	-	-
RS-485 output (B MODELS)		-	Compliant with the RS-485 standard min Baud Rate = 2400 / max Baud Rate =115200 (configurable function)	-
Inputs		Input with configurable functions (0/24 VDC)	Input with configurable functions (0/24 VDC)	-
Minimum duration of Input signal (ms)		5	5	-
Max. connect. length	m	50	50	100
Operating temp.	°C	-10 ÷ 55°C	-10 ÷ 55°C	-10 ÷ 55°C
Protection class		IP 65 - IP 67	IP 65 - IP 67	IP 65 - IP 67

Beam spacing 5 mm																				
Model	150	300	450	600	750	900	1050	1200	1350	1500										
Measurement height (mm)	145	295	395	595	745	895	1045	1195	1345	1495										
Number of beams	30	60	90	120	150	180	210	240	270	300										
Beam spacing 10 mm																				
Model	151	301	451	601	751	901	1051	1201	1351	1501	1651	1801	1951	2101	2251	2401	2551	2701	2851	3001
Measurement height (mm)	140	290	440	590	740	890	1040	1190	1340	1490	1640	1790	1940	2090	2240	2390	2540	2690	2840	2990
Number of beams	15	30	45	60	75	90	105	120	135	150	165	180	195	210	225	240	255	270	285	300
Beam spacing 20 mm																				
Model	150-20	300-20	450-20	600-20	750-20	900-20	1050-20	1200-20	1350-20	1500-20	1650-20	1800-20	1950-20	2100-20	2250-20	2400-20	2550-20	2700-20	2850-20	3000-20
Measurement height (mm)	130	280	430	580	730	880	1030	1180	1330	1480	1630	1780	1930	2080	2230	2380	2530	2680	2830	2980
Number of beams	8	15	23	30	38	45	53	60	68	75	83	90	98	105	113	120	128	135	143	150
Beam spacing 25 mm																				
Model	152	302	452	602	752	902	1052	1202	1352	1502	1652	1802	1952	2102	2252	2402	2552	2702	2852	3002
Measurement height (mm)	125	275	425	575	725	875	1025	1175	1325	1475	1625	1775	1925	2075	2225	2375	2525	2675	2825	2975
Number of beams	6	12	18	24	30	36	42	48	54	60	66	72	78	84	90	96	102	108	114	120
Beam spacing 30 mm																				
Model	153	303	453	603	753	903	1053	1203	1353	1503	1653	1803	1953	2103	2253	2403	2553	2703	2853	3003
Measurement height (mm)	120	270	420	570	720	870	1020	1170	1320	1470	1620	1770	1920	2070	2220	2370	2520	2670	2820	2970
Number of beams	5	10	15	20	25	30	35	40	45	50	55	60	65	70	75	80	85	90	95	100
Beam spacing 50 mm																				
Model	155	305	455	605	755	905	1055	1205	1355	1505	1655	1805	1955	2105	2255	2405	2555	2705	2855	3005
Measurement height (mm)	100	250	400	550	700	850	1000	1150	1300	1450	1600	1750	1900	2050	2200	2350	2500	2650	2800	2950
Number of beams	3	6	9	12	15	18	21	24	27	30	33	36	39	42	45	48	51	54	57	60
Beam spacing 75 mm																				
Model	157	307	457	607	757	907	1057	1207	1357	1507	1657	1807	1957	2107	2257	2407	2557	2707	2857	3007
Measurement height (mm)	75	225	375	525	675	825	975	1125	1275	1425	1575	1725	1875	2025	2175	2325	2475	2625	2775	2925
Number of beams	2	4	6	8	10	12	14	16	18	20	22	24	26	28	30	32	34	36	38	40

Mechanical dimensions (all measurements are in mm)

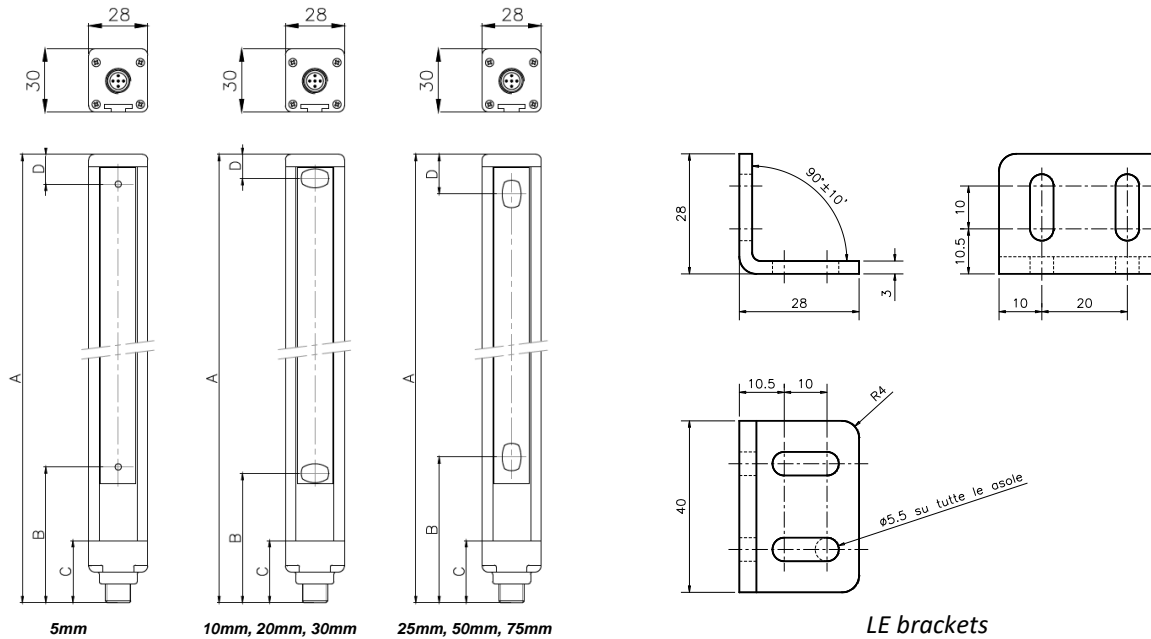

	150	300	450	600	750	900	1050	1200	1350	1500	1650	1800	1950	2100	2250	2400	2550	2700	2850	3000
Dimension A	213	363	513	663	813	963	1113	1263	1413	1563	1713	1863	2013	2163	2313	2463	2613	2763	2913	3063
Dimension A (step 5mm)	223	373	523	673	823	973	1123	1273	1423	1573	-	-	-	-	-	-	-	-	-	-
Dimension B (step 5mm)	64,5	64,5	64,5	64,5	64,5	64,5	64,5	64,5	64,5	64,5	-	-	-	-	-	-	-	-	-	-
Dimension B (step 10mm, 20mm, 30mm)	61,5	61,5	61,5	61,5	61,5	61,5	61,5	61,5	61,5	61,5	61,5	61,5	61,5	61,5	61,5	61,5	61,5	61,5	61,5	61,5
Dimension B (step 25mm, 50mm, 75mm)	69	69	69	69	69	69	69	69	69	69	69	69	69	69	69	69	69	69	69	69
Dimension C	29	29	29	29	29	29	29	29	29	29	29	29	29	29	29	29	29	29	29	29
Dimension D (step 5mm)	13	13	13	13	13	13	13	13	13	13	-	-	-	-	-	-	-	-	-	-
Dimension D (step 10mm)	11	11	11	11	11	11	11	11	11	11	11	11	11	11	11	11	11	11	11	11
Dimension D (step 20mm)	11	21	11	21	11	21	11	21	11	21	11	21	11	21	11	21	11	21	11	21
Dimension D (step 25mm)	19	19	19	19	19	19	19	19	19	19	19	19	19	19	19	19	19	19	19	19
Dimension D (step 30mm)	31	31	31	31	31	31	31	31	31	31	31	31	31	31	31	31	31	31	31	31
Dimension D (step 50mm)	44	44	44	44	44	44	44	44	44	44	44	44	44	44	44	44	44	44	44	44
Dimension D (step 75mm)	69	69	69	69	69	69	69	69	69	69	69	69	69	69	69	69	69	69	69	69
Mounting	2 LE TYPE brackets with 2 inserts								3 LE TYPE brackets with 2 inserts											

CONFIGURATION SOFTWARE

Using the *ReeR MICRONCONFIGURATOR* program

The Micron is provided with a connector on the receiver (see the connections section) for connection to a PC via USB link. The function programming system (*ReeR MICRONCONFIGURATOR*) can be used to configure the Micron by setting the conditions for activating the outputs (these can also be combined by using the NULL/AND/OR operators). The following conditions can be selected:

- **FBO** First beam obstructed
- **LBO** Last beam obstructed
- **CBO** Central beam obstructed *
- **NBO** Number of beams obstructed
- **NCBO** Maximum number of consecutive beams obstructed *
- **BNO** Beam n obstructed

*** If more than one zone is obstructed, the data refer to the zone with the highest number of obstructed beams.**

A graphic interface can also be displayed for real-time monitoring of light curtain conditions. The following figures illustrate some screen pages of the *ReeR MicronConfigurator* program which can be used to configure the Micron's operating logic.

Preliminary Operations

Insert the MICRONCONFIGURATOR CD-ROM in the computer and follow the software installation instructions. To launch *MicronConfigurator*, double-click the icon created on the desktop.

LIGHT CURTAIN
MODEL AND DATA

Micron
INITIAL
CONFIGURATION (1)

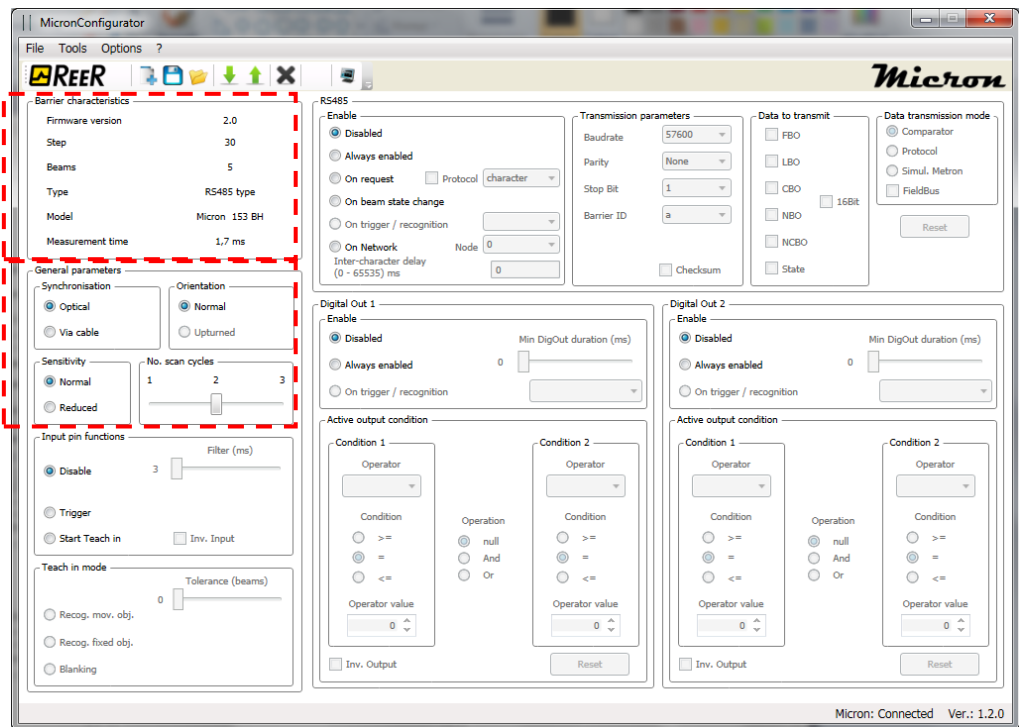



Figure 10

Even if the light curtain is not connected you can still fill in the configuration fields and save the configuration on the PC, using the icon. You will be able to retrieve the previously saved configuration later, by clicking .

Connecting/disconnecting the light curtain

The "**Barrier characteristics**" panel in the top left corner is filled in automatically a few seconds after establishing the USB connection.

Click  (upload) to send the configuration to the Micron: at the end of this procedure the light curtain will automatically restart using the new configuration.

Click  (download) to read the configuration on the Micron; the program will display the data relating to the retrieved configuration.

Initial configuration (1)

Sync configuration:

TX-RX synchronisation can be programmed as follows:

SYNC VIA CABLE	Connect the SYNC signals of the emitter and the receiver.
OPTICAL SYNC	Sync the devices using the last beam of the light curtain.

- ➔ With optical synchronisation, the uppermost beam must never be obstructed otherwise the measurement function will be interrupted.
- ➔ With cable synchronisation, digital output 2 cannot be used.
- ➔ To switch from cable to optical synchronisation, the emitter must be switched off and then restarted.

Receiver sensitivity configuration (only models 25mm, 50mm, 75mm, 10mm H, 30mm H):

The receiver's sensitivity can be adjusted depending on its distance from the emitter.

NORMAL SENSITIVITY	Recommended for d > 50 cm
REDUCED SENSITIVITY	Recommended for d < 50 cm

- ➔ With reduced sensitivity it is advisable to select the low range on the emitter.

Orientation configuration:

Beam numbering can be configured according to the orientation of the light curtain:

NORMAL ORIENTATION	Connectors low - first beam at bottom
UPTURNED ORIENTATION	Connectors high - first beam at bottom

- ➔ With optical synchronisation light curtain orientation must be normal.

Scan cycle configuration:

The number of cycles used to perform the measurement can be configured:

1	Single cycle: fast but inaccurate measurement sensitive to light disturbance
2	two cycles: measurement with good speed-precision balance
3	three cycles: accurate measurement, insensitive to light disturbance but slower

- ➔ Measurement time depends on the number of programmed cycles according to the formula:

$$(0,07\text{ms} * \text{number of beams} + 500 \text{ us}) * n \text{ ms}$$
(n configurable 1÷3 based on the scan cycles configured).

INPUT PIN CONFIGURATION (2)

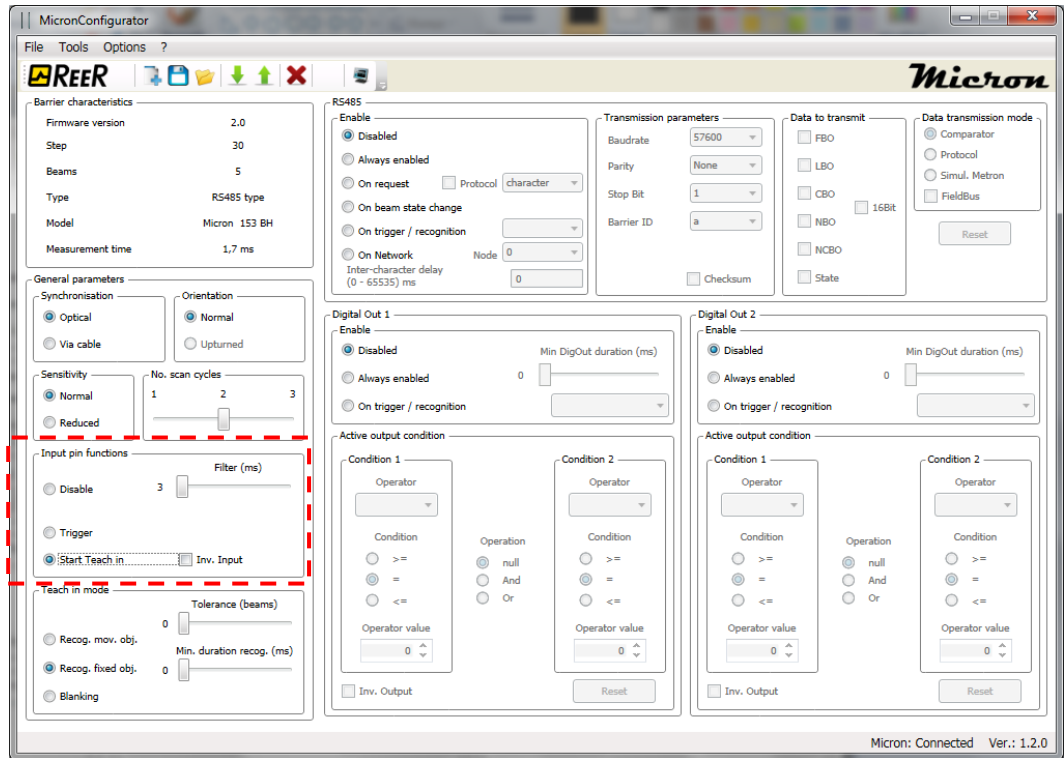

Figure 11

Input pin configuration (2)

The input pin can be configured as follows:

- **No function** (disabled).
- **Trigger function:** this can be used to enable analog and digital outputs, stand-by and start/stop measurements. In this mode the minimum internal trigger time can be set to between 0 and 250 ms. (The BLUE LED lights up to indicate that the input is active).
- **Teach-in function** The pin can be used to teach the light curtain the pattern of an object using the following procedure:

	ACTION	BLUE LED
1	No pattern	Blue LED blinks three times
2	Connect the input pin to 24 VDC	Blue LED blinks continuously
3	Enter the object to be recognised in the light curtain's measurement field	Blue LED blinks continuously
4	Disconnect the input pin	Blue LED blinks twice followed by a light curtain auto-reset procedure
5	Recognition active	Blue LED constantly on

To delete the pattern of the object that has been saved, repeat the procedure described above with the measurement field empty.

For recognition mode please refer to the relevant chapter.

The filter on the input pin can be set to between 3 and 250 ms (impulses shorter than the set value are not considered). This signal is active high but the logic can be inverted (active low) using the *Inv.Input* box.

TEACH IN mode (3)

When the input pin is configured as *Teach in* the “Teach in mode” panel is active.

Teach in mode is used when the light curtain must recognise a specific object or pattern. There are three possible options:

	MODE	DESCRIPTION
1	Recognition of a moving object	The object to be recognised must be compact (with no transparent parts) and obstruct a certain number of adjacent beams. The light curtain recognises the object saved previously in any position within the measurement field.
2	Recognition of a fixed object (pattern)	The object to be recognised can be of any shape, it need not be continuous and may have transparent parts. The light curtain only recognises the object if it obstructs the same position (in the measurement field) as when it was saved.
3	Blanking	The object to be recognised can be of any shape, it need not be continuous and may have transparent parts. In this case it will be parts of a machine (guards, arms, etc.) that obstruct part of the field of vision. The light curtain treats the object as non-existent and ignores it in the measurements.

- ➔ In cases 1 and 2, the blue LED blinks to indicate that the object has been recognised. Recognition generates an internal trigger logic signal which can thus be used to activate outputs, enable stand by, etc.
- ➔ It is possible to select a tolerance of 0 to 2 beams for recognition.
- ➔ With particularly fast-moving objects, the minimum length of the internal trigger signal can be set to between 0 and 250 ms.
- ➔ The light curtain is capable of saving 2 different patterns for modes 1 and 2.
- ➔ Click to delete previously saved patterns.

TEACH IN mode (3)

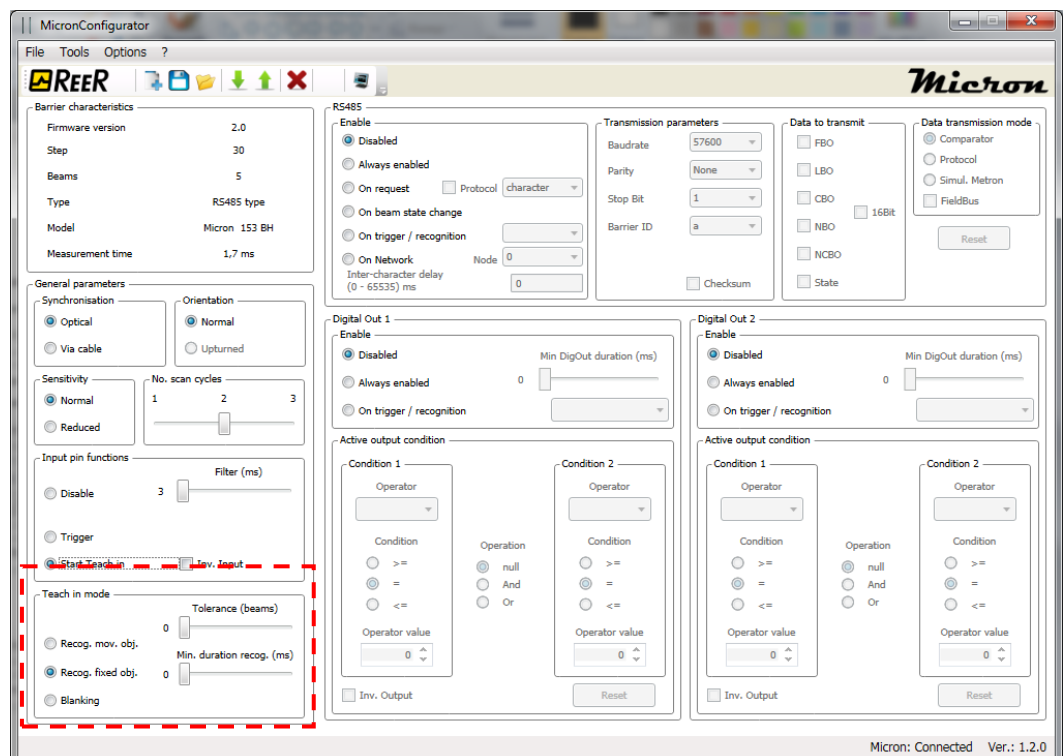
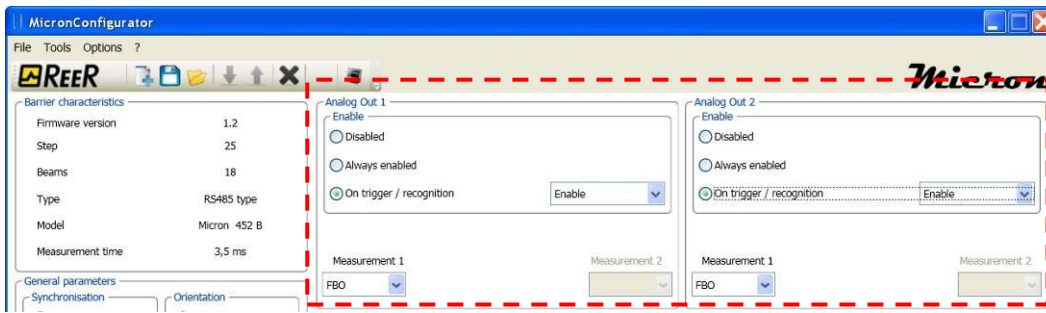

Figure 12

Analog output configuration (AC/AV models) (4)



ANALOG OUTPUT CONFIGURATION (4)

Figure 13

It is possible to configure the conditions for activating each single output.
Use the “ENABLE” box to select the conditions for activating each analog output.

	MODE	DESCRIPTION
1	Output disabled	The output is not active and gives 0 V in AV models and 4 mA in AC models
2	Output always enabled	The output always gives the analog value for the measurement selected.
3	Upon trigger/recognition	CHOOSE BETWEEN:
a.	Enable	<ul style="list-style-type: none"> With input not active/object not recognised the output gives 0 V in AV models and 4 mA in AC models With input active/object recognised the output continuously gives the analog value corresponding to the measurement detected.
b.	Stand by	<ul style="list-style-type: none"> With input not active/object not recognised the output continuously gives the analog value corresponding to the measurement detected. With input active/object recognised the output keeps the last value given.
c.	Start/stop	<ul style="list-style-type: none"> With input active/object recognised the light curtain starts a measurement session by saving the highest value of the selected measurement. When input deactivated/object not recognised, the output gives the analog value corresponding to the maximum value detected for the selected measurement. This value stays on the output until the next Start/stop session.
d.	Switch measurement	<ul style="list-style-type: none"> With input not active/object not recognised the output continuously gives the analog value corresponding to the measurement selected in the Measurement 1 box. With input active/object recognised the output continuously gives the analog value corresponding to the measurement selected in the Measurement 2 box.

The following measurements can be selected to apply to the output:

- **FBO** First beam obstructed
- **LBO** Last beam obstructed
- **CBO** Central beam obstructed
- **NBO** Number of beams obstructed
- **NCBO** Maximum number of consecutive beams obstructed

AV light curtains output a voltage that is proportionate to the measurement performed according to the following formula:

$$Vo = ((10V / \text{number of beams}) * \text{measurement}) \pm 2\%$$

E.g.: with a 30-beam light curtain and an NBO measurement of 15, the Micron outputs:

$$Vo = ((10V / 30) * 15) \pm 2\% = 5V \pm 2\%$$

AC light curtains output a current that is proportionate to the measurement performed according to the following formula:

$$Io = (((16mA / \text{number of beams}) * \text{measurement}) + 4mA) \pm 2\%$$

E.g.: with a 26-beam light curtain and an LBO measurement of 13, the Micron outputs:

$$Io = (((16mA / 26) * 13) + 4mA) \pm 2\% = 12mA \pm 2\%$$

Digital output configuration (5)

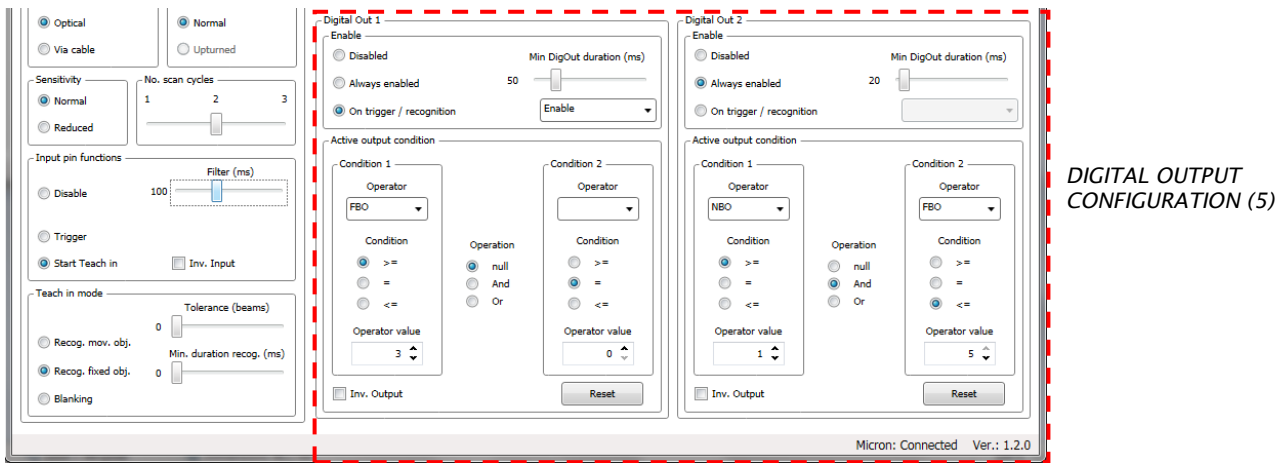

Figure 14

The conditions for activating each digital output can be selected in the "ENABLE" panel.

	MODE	DESCRIPTION
1	Output disabled	The output is not active and gives 0 VDC
2	Output always enabled	The output is active and gives 0 VDC or 24 VDC depending on the set condition. (-> "Active Output Condition" panel)
3	Upon trigger/recognition	CHOOSE BETWEEN:
a.	Enable	<ul style="list-style-type: none"> With input not active/object not recognised the output gives 0 VDC With input active/object recognised the output is active and gives 0 VDC or 24 VDC depending on the set condition
b.	Stand by	<ul style="list-style-type: none"> With input not active/object not recognised the output gives 0 VDC or 24 VDC depending on the set condition With input active/object recognised the output keeps the last logic level given.
c.	Start/stop	<ul style="list-style-type: none"> With input active/object recognised the light curtain starts a measurement session by saving whether (in this condition) the set condition occurs. When input deactivated/object not recognised, the digital output switches to 0 VDC or 24 VDC if the set condition occurred in the previous session. This output value is maintained until the next Start/stop session.
d.	Switch condition	<ul style="list-style-type: none"> With input not active/object not recognised the digital output follows the condition set in the left-hand column (condition 1). With input active/object recognised the digital output follows the condition set in the right-hand column (condition 2).
c.	Copy	<ul style="list-style-type: none"> The output copies the input status/object recognised: With input active/object recognised the digital output gives 24 VDC With input not active/object not recognised the output gives 0 VDC

With fast output switching, the **minimum output time** can be set to between 0 and 250 ms.

The CONDITION box

The "CONDIZIONE" box can be used to set the condition for switching the output to LL1 (24 VDC):

<i>First select operator 1 in the left-hand column. The program offers a choice of the following conditions:</i>	<i>Select the condition:</i>	<i>Select the value.</i>
<ul style="list-style-type: none"> • FBO First beam obstructed • LBO Last beam obstructed • CBO Central beam obstructed • NBO Number of beams obstructed • NCBO Maximum number of consecutive beams obstructed • BNO Beam n obstructed 	<ul style="list-style-type: none"> • >= • = • <= 	E.g.: 12

Example:

*to switch the output to LL1 if the last obstructed beam is more than or equal to 12, select: **LBO, >=, 12***

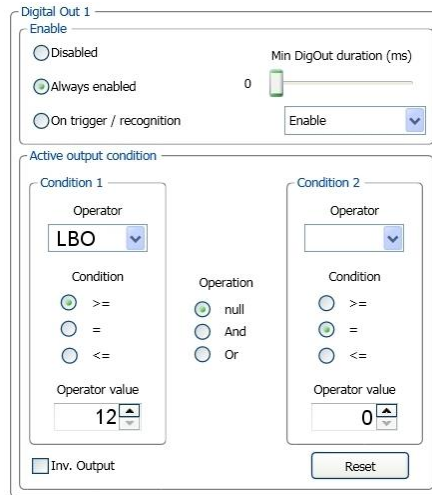

Figure 15

Use the OR and AND operators to define more complex logic conditions and establish relationships between the conditions in the LH column to those in the RH column.

Example:

*to switch the output to LL1 if the last obstructed beam is more than or equal to 12, and there are 5 obstructed beams, select: **LBO, >=, 12 AND NBO, =, 5***

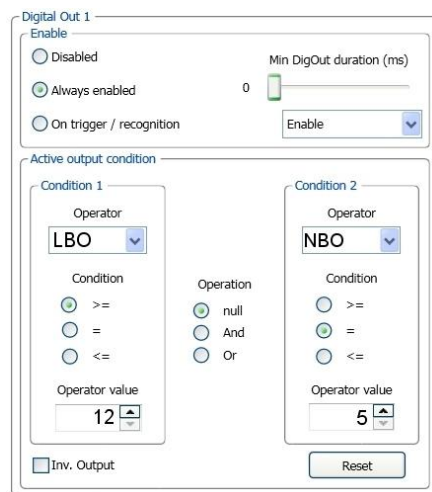
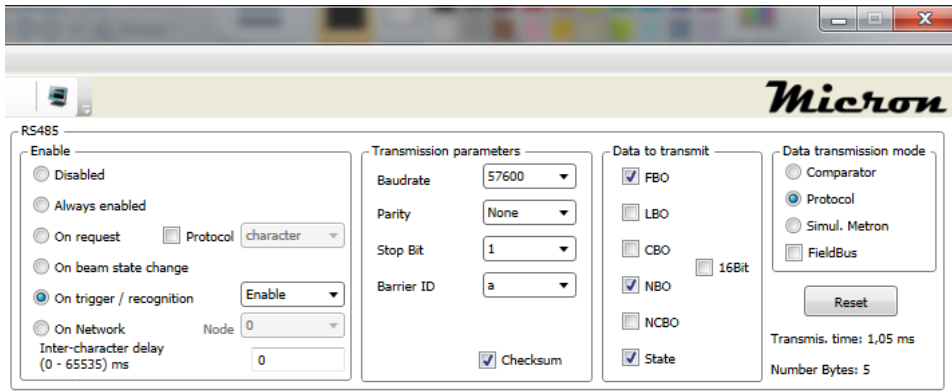

Figure 16

RS485 output configuration (B models) (6)



RS485 CONFIGURATION (6)

Figure 17

The conditions for activating RS485 serial data transmission can be selected in the "ENABLE" panel.

Enable

	MODE	DESCRIPTION
1	RS485 disabled	Data transmission not active
2	RS485 always enabled	Data transmission always active
3	RS485 upon request	Data transmission only starts upon recognition of a character that is received. The character is user-definable
4	RS485 upon beam status change	Data transmission is activated when the beam status changes.
5	Upon trigger/recognition	CHOOSE BETWEEN:
a.	Enable	<ul style="list-style-type: none"> ▪ With input not active/object not recognised data transmission is not active ▪ With input active/object recognised data transmission is always active
b.	Stand by	<ul style="list-style-type: none"> ▪ With input not active/object not recognised data transmission is always active ▪ With input active/object recognised data transmission repeats the last datum sent
c.	Start/stop	<ul style="list-style-type: none"> ▪ With input active/object recognised the light curtain starts a measurement session by saving the highest value of the selected measurement. ▪ When input deactivated/object not recognised, data transmission gives the maximum value corresponding to the selected measurement once
d.	One shot	<ul style="list-style-type: none"> ▪ With input not active/object not recognised data transmission is deactivated ▪ With input active/object recognised data transmission gives the selected measurement once
6	On Network	Up to 3 Micron B can be connected on Network -> Micron on Network

Inter-character delay: in the case of always active data transmission, the inter-character delay between one data packet and the next can be customised by changing the "INTERCHARACTER DELAY" parameter. The program checks that the selected inter-character delay is compatible with the data transmission parameters. An Inter-character delay of zero indicates that transmission of the next data packet will start as soon as the next measurement is available.

Micron on Network

Micron barrier can be connected on Network; the maximum number of barriers is **3**.

- The first barrier will be programmed with **node=0**.
- The other barriers will have a node sequential and different from 0 numeration.
- The RS-485 outputs (pin 5 or 6) will be connected in parallel.
- The 0V connection must be common.
- No need of termination resistor.

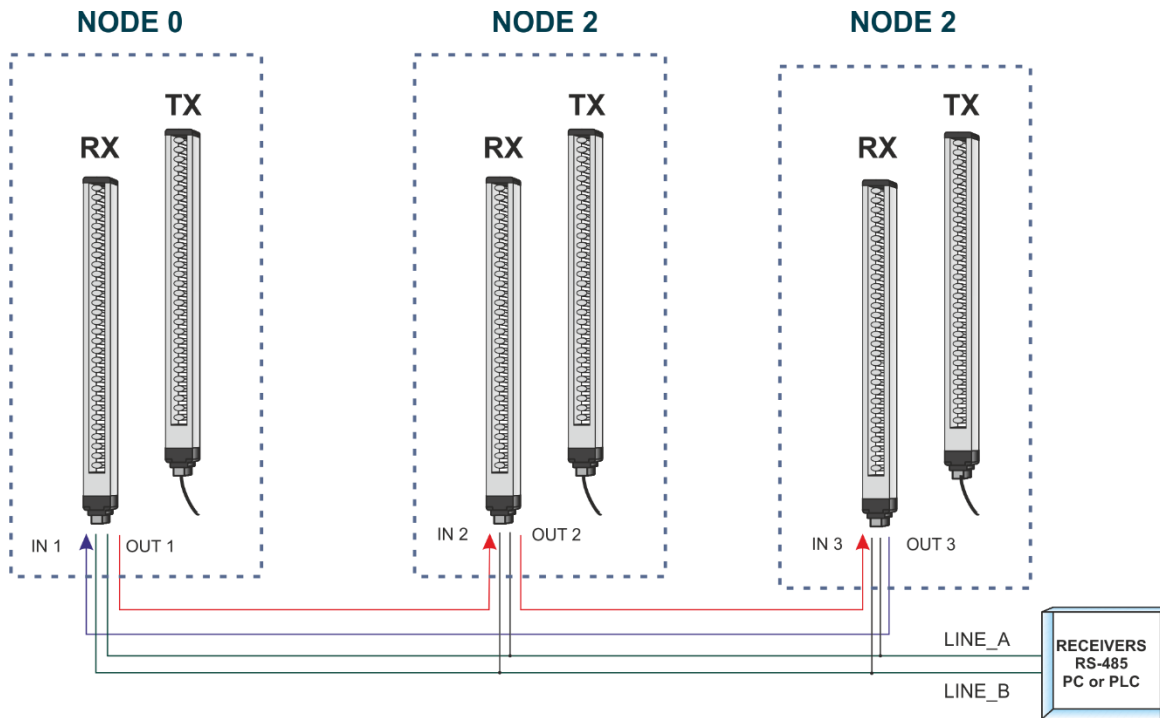

Figure 18

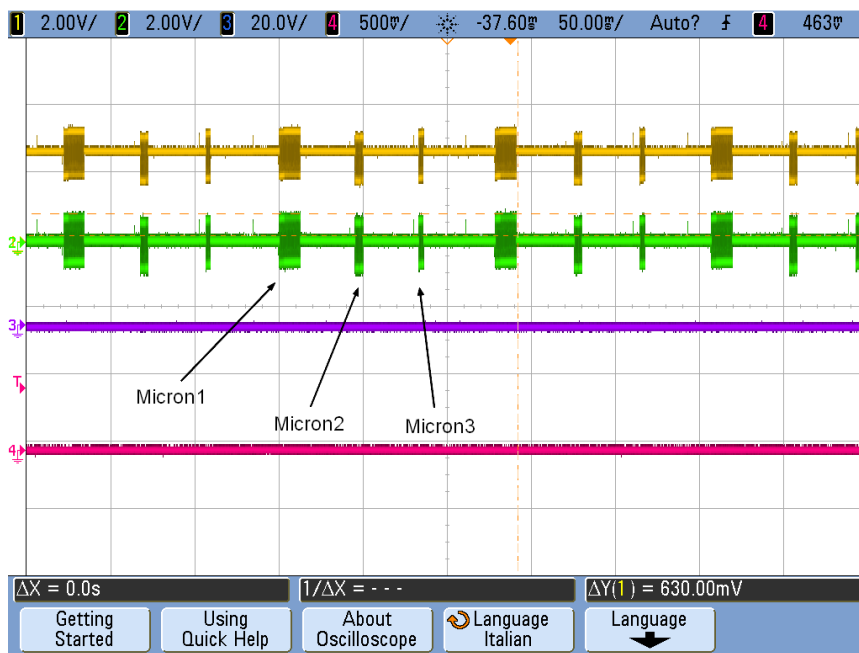

Figure 19 – sequential data transmission on RS-485 outputs

Data transmission parameters

PARAMETER		DESCRIPTION
1	Baudrate	2400, 4800, 9600, 19200, 38400, 57600, 115200
2	Parity	Even, odd, none
3	Stop bit	1, 2
4	RS485 upon beam status change	Data transmission is activated when the beam status changes.
5	light curtain ID	This character identifies the light curtain so that several light curtains can be connected on the same RS485 link.
6	Checksum	In data transmission mode Protocol adds a checksum byte to the data packet

Data to be sent

FBO	First obstructed beam
LBO	Last obstructed beam
CBO	Central beam obstructed
NBO	Number of obstructed beams
NCBO	Maximum number of consecutive beams obstructed
Status	Status of all beams: 1 corresponds to beam clear, the first beam is represented by the MSB of the first byte. Bits with no corresponding beam are zero. The number of bytes transmitted is given by the number of beams/8 approximated by excess. E.g.: a 26-beam light curtain will send $26/8 = 3.25 \rightarrow 4$ bytes in which of the last byte only the 2 most significant bits are valid.
16 bit	Provides (when selected) the measures in 16 bit (2 bytes) format

Data transmission mode

In “Comparator” mode the light curtain sends a number of bytes corresponding to the measurements selected in the “Data to be sent” section containing the current value of the measurements.

In “Protocol” mode the light curtain sends a data packet with the following format:

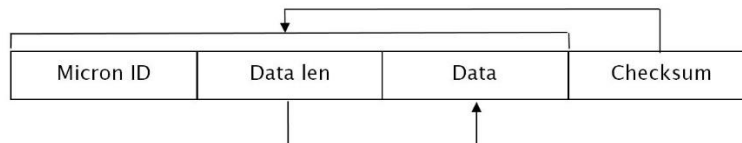

“Micron ID” is a 1-byte field. It contains the character selected in parameter 4 of the “Data transmission parameters” section.

“Data len” is a 1-byte field and contains the number of bytes corresponding to the measurements selected in the “Data to be sent” section.

The “Data” field consists of the number of bytes indicated by the previous Data len field and contains the current value of the measurements selected in the “Data to be sent” section.

DATA FORMAT	
NUMBER OF BEAMS	DATA FORMAT
≤ 255	8 bit
> 255	16 bit

“Checksum” is a 1-byte field and contains the complement to 1 of the sum of all the bytes in the message except itself. The Checksum field is only present if selected in the “Data transmission parameters” section.

In “Metron simulation” mode the barrier will send data simulating the METRON B in “Binary” mode.

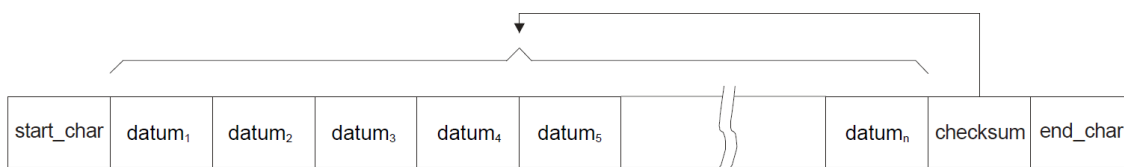

In “FieldBus” mode must be selected when the barrier is coupled with a Reer FieldBus module.

Comparator mode

The following figure shows a scheme of the data packet sent by the light curtain in comparator mode.

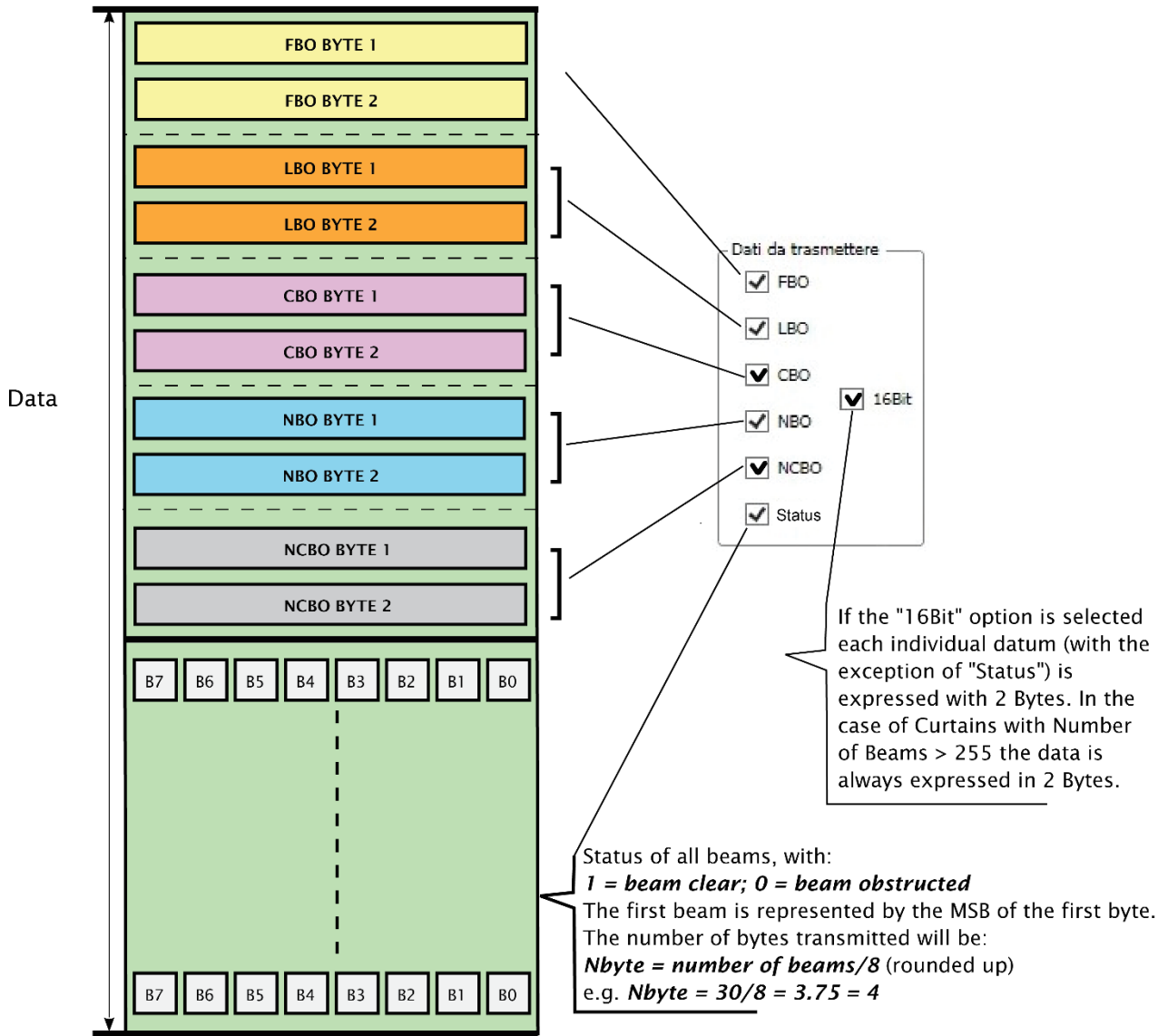

Figure 20

Protocol mode

The following figure shows a scheme of the data packet sent by the light curtain in protocol mode.

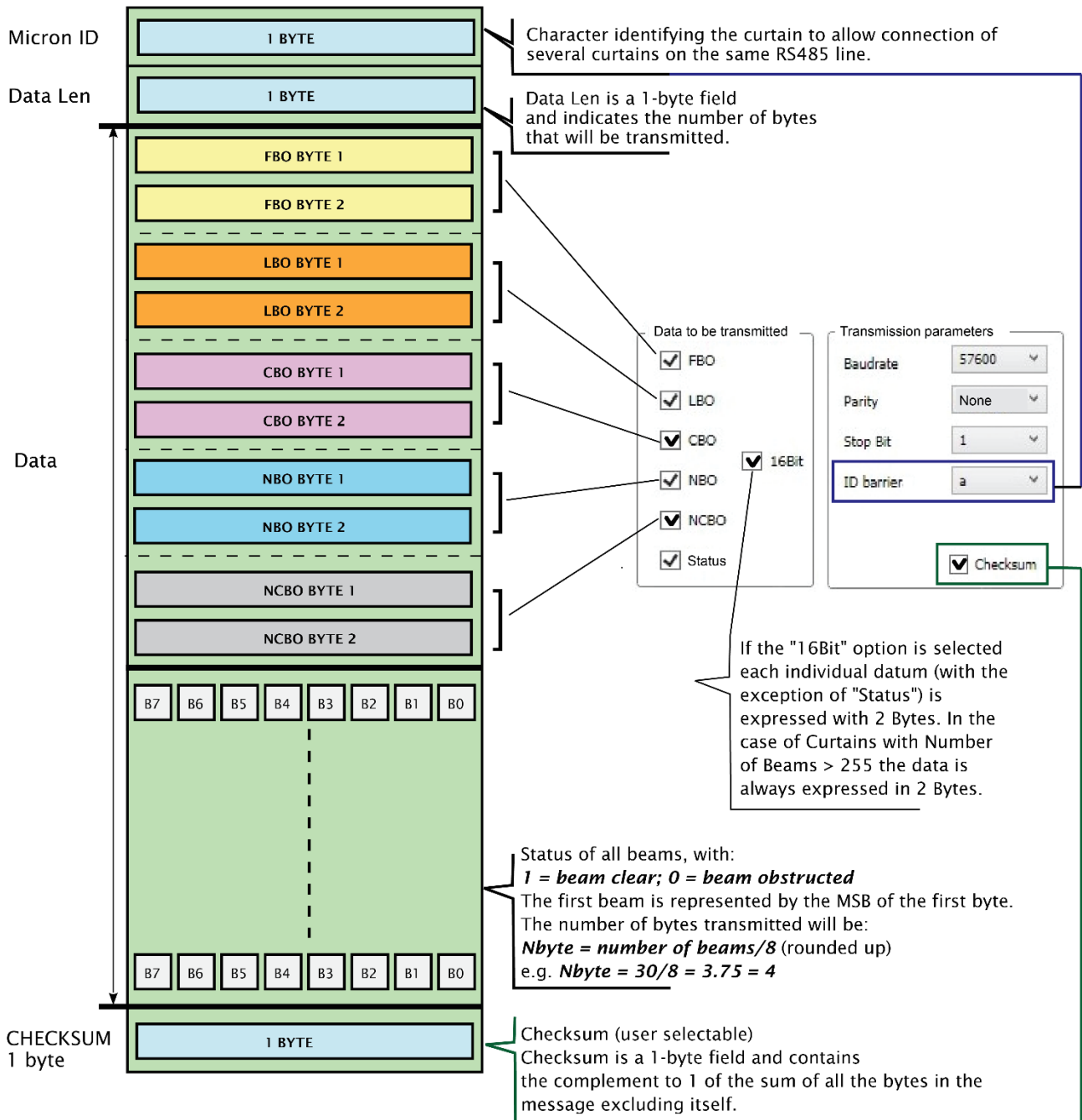
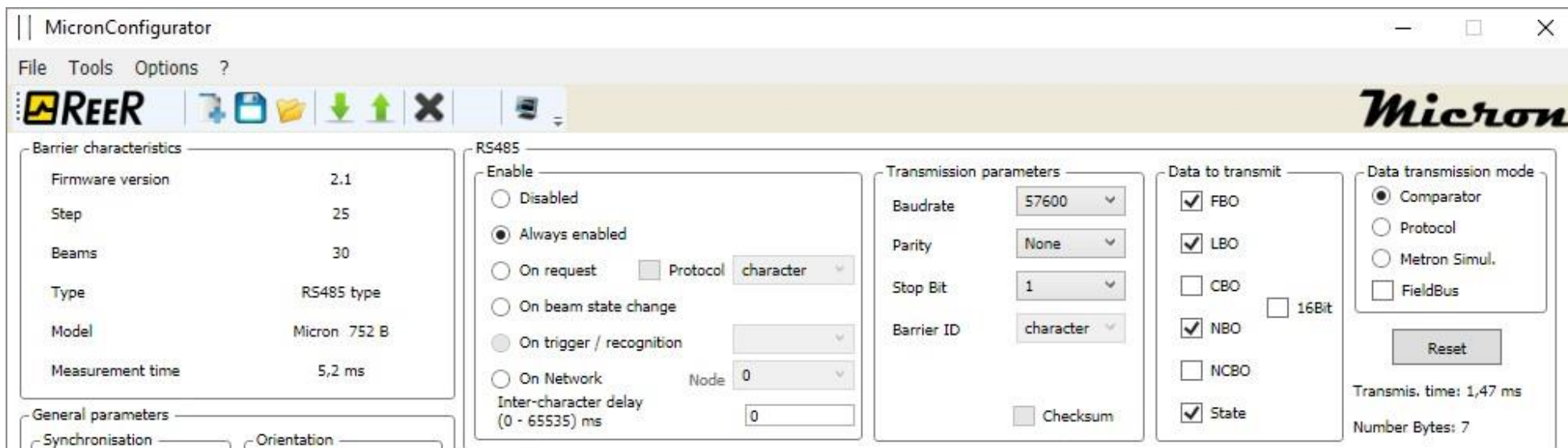

Figure 21

Example of data packet in comparator mode



BEAMS STATUS (1->beam clear; 0->beam obstructed; x->don't care)

13	22	5	1	1	1	1	1	1	1	1	1	1	1	0	0	1	1	1	1	1	0	0	0	1	1	1	1	1	1	x	x						
FBO	LBO	NBO	8					9					16					17					24					25					32				
7 BYTES IN TOTAL																																					

Example of data packet in protocol mode

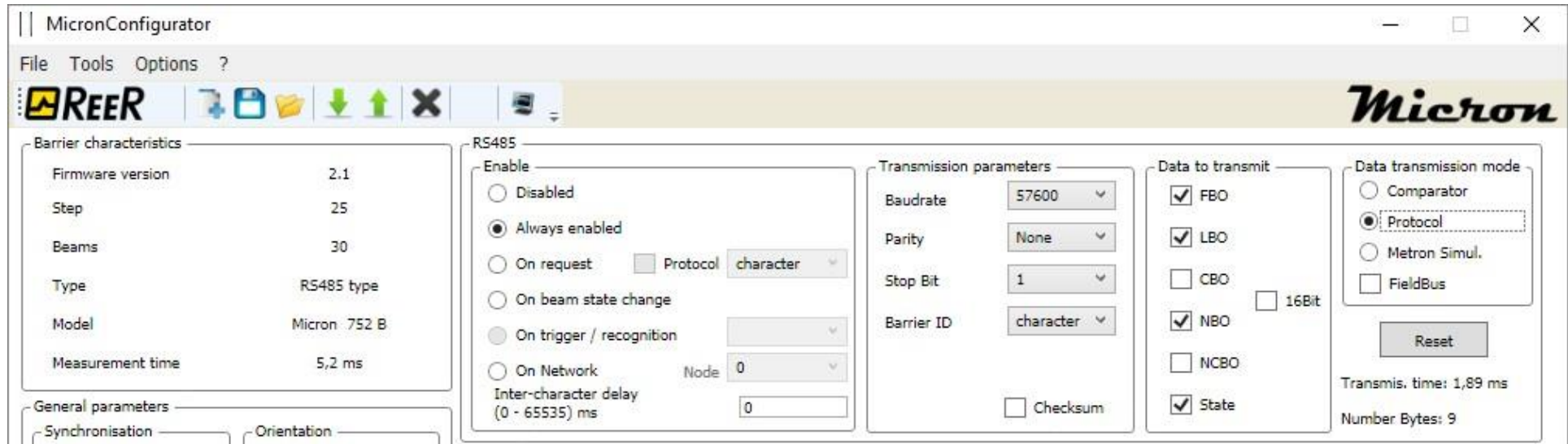

BEAMS STATUS (1->beam clear; 0->beam obstructed; x->don't care)

a	7	4	26	7	1	1	1	0	0	0	1	1	1	1	1	1	1	1	1	1	1	0	0	0	0	1	1	1	1	x	x
ID	Length	FBO	LBO	NBO	8								9	16								17	24				25	32			

9 BYTES IN TOTAL

Monitoring light curtain status

AV/AC models

Click  "MONITOR" to open a graphic user interface that displays light curtain operation in real time. The following information is given:

1. Model and data of the light curtain connected
2. Synchronisation (optical or via cable)
3. Sensitivity
4. Orientation (normal or upturned)
5. Scan cycles
6. Graphic representation of the MICRON beams (in real time)
7. Graphic representation of cable synchronisation (not displayed with optical synchronisation)
8. Measurements performed (in real time)
9. Input status (in real time)
10. Pattern present (in real time)
11. Object recognition (in real time)
12. Value of analog outputs (in real time)
13. Status of digital outputs (in real time)

Next time you click  the program returns to the configuration screen page.

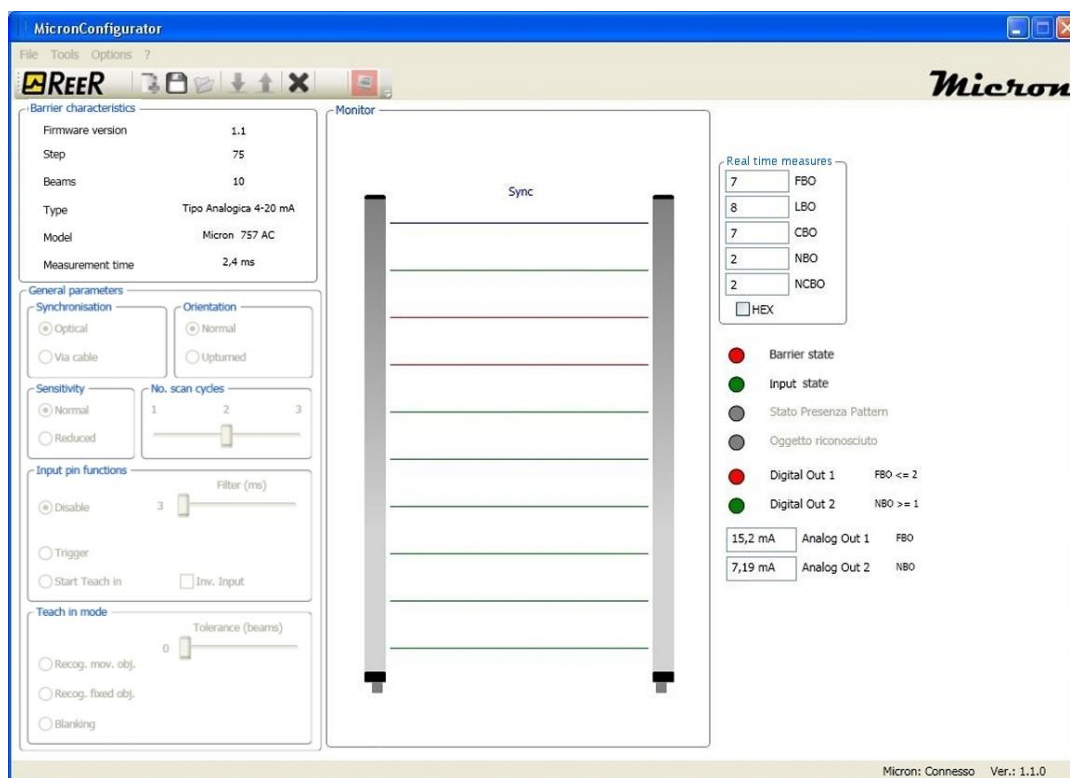



Figure 20 – AV/AC MODELS

B models

Click  "MONITOR" to open a graphic user interface that displays light curtain operation in real time. The following information is given:

1. Model and data of the light curtain connected
2. Synchronisation (optical or via cable)
3. Sensitivity
4. Orientation (normal or upturned)
5. Scan cycles
6. Graphic representation of the MICRON beams (in real time)
7. Graphic representation of cable synchronisation (not displayed with optical synchronisation)
8. Data sent via the RS485 link (in real time). You may stop the flow of data, delete the contents of the window and copy the data to the Windows clipboard.
9. Data transmission time
10. RS-485 configuration
11. Measurements performed (in real time)
12. Input status (in real time)
13. Pattern present (in real time)
14. Object recognition (in real time)
15. Status of digital outputs (in real time)

Next time you click  the program returns to the configuration screen page.

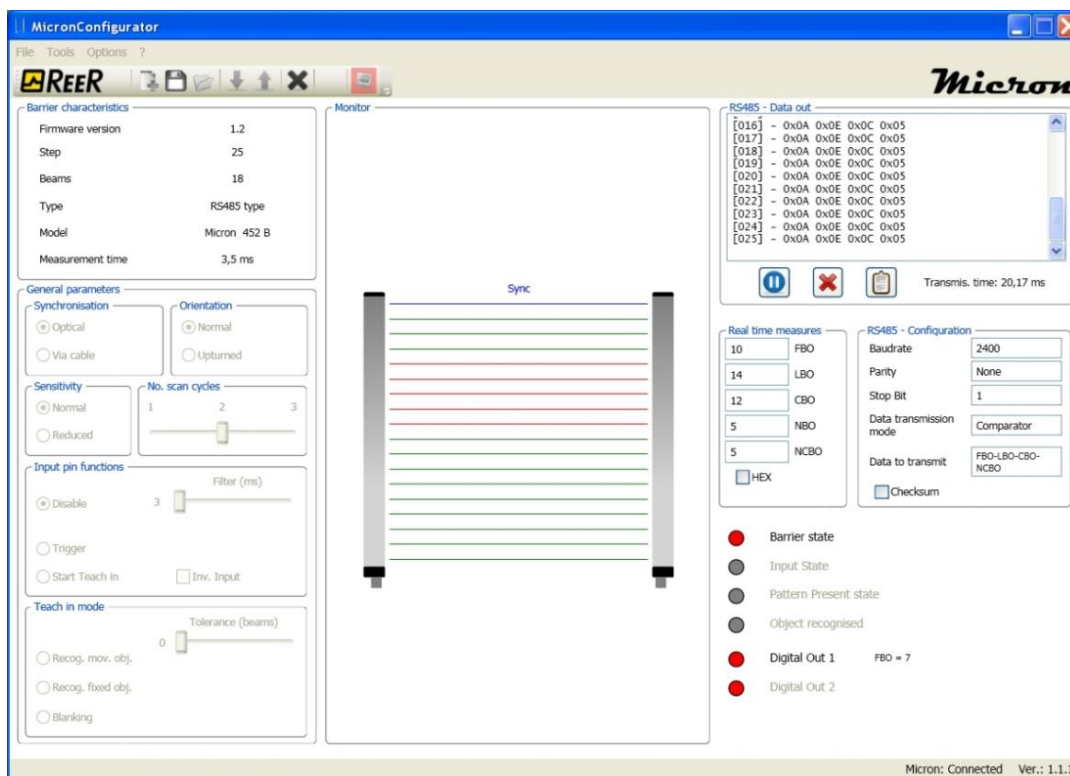

Figure 21 – B MODELS



Dichiarazione CE di conformità
EC declaration of conformity

Torino, 21/03/2016

REER SpA
via Carcano 32
10153 – Torino
Italy

dichiara che:

- le barriere fotoelettriche **MICRON**
- le interfacce BUS della serie **MI-B**

sono dispositivi optoelettronici di misura realizzati in conformità alle seguenti Direttive Europee:

declares that:

- *the **MICRON** photoelectric barriers*
- *the **MI-B** series BUS interfaces*

are Electro-sensitive Measuring Equipments compliant with the following European Directives:

- **2014/30/EU** "Direttiva Compatibilità Elettromagnetica"
"Electromagnetic Compatibility Directive"
- **2014/35/EU** "Direttiva Bassa Tensione"
"Low Voltage Directive"

Carlo Pautasso
Direttore Tecnico
Technical Director

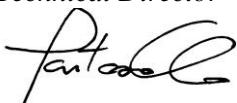

Simone Scaravelli
Amministratore Delegato
Managing director

